

# HTPA32x32dR2L1.6/0.8F5.0

Datasheet for Thermopile Array Sensor with Lens Optic

## **DISCLAIMER**

We reserve the right to correct or update the content, technical specifications or product descriptions at any time without prior notification.

All information is provided "as is", without any warranty, express or implied, including but not limited to warranties of merchantability or fitness for a particular purpose.

To ensure you are using the most up-to-date and accurate version, please always refer to the latest edition available on our official website.

Only the version published on the website shall be considered authoritative and current.

## Content

Changelog .....	3
1 Cleaning and Handling of Sensors with Optical Elements .....	5
2 Principal Schematic for HTPA32x32d .....	7
3 Pin Assignment–Bottom View .....	7
4 Optical Orientation .....	8
5 Order Code Example .....	9
6 Application Note .....	10
7 Serial Order of Frame .....	11
8 Characteristics .....	12
8.1 Common Specifications .....	12
8.2 Optical Characteristics .....	12
9 Electric Specifications .....	14
10 I <sup>2</sup> C Timings HTPA32x32d .....	15
11 I <sup>2</sup> C Communication .....	16
11.1 Write Command .....	16
11.2 Read Command .....	16
11.3 Sensor Commands .....	16
11.4 EEPROM Communication .....	19
11.5 I <sup>2</sup> C Example Sequences – Init and Read Thermopile Array .....	20
12 Temperature Calculation .....	21
12.1 Ambient Temperature .....	23
12.2 Thermal Offset .....	23
12.3 Electrical Offset .....	23
12.4 Vdd Compensation .....	24
12.5 Object Temperature .....	25
13 Example Calculation .....	26
13.1 Pixel Masking .....	28
13.2 Look-up Table .....	31
14 Order Code Chart .....	32
15 Outer Dimension .....	33

## Changelog

2018-11-05	Pixelmask corrected; added startup time of 100µs
2018-11-29	Added eHis drawing for L5.0
2018-12-10	Added radiometric radius and accuracy for L2.1
2019-01-11	Added accuracy and erase default values for TRIM registers
2019-03-01	Added handling advice
2019-03-08	Revised L5.0 drawing with index tap width
2019-03-20	Adapted radiometric radius accuracy; revised soldering height
2019-04-24	Drawing for soldering height adapted
2019-07-05	Revised typical and max current consumption
2019-09-26	Added radiometric radius for L4.0
2020-05-11	Adapted soldering recommendations for non SMD
2020-09-05	Added stack buffer recommendation; how to dk to °C; EEPROM link; pixel mask correction
2020-09-17	Added FoV for L1.6
2021-08-12	New order code
2021-11-16	Updated FoV 50 % Sensitivity, added graph for FoV, specified accuracy
2022-04-27	Corrected pinout in circuit schematic
2024-05-02	Revised L1.7 drawing with updated cap design
2024-10-10	Changed storage and operating temperatures
2024-10-10	Added relative humidity
2024-12-18	Updated graphic for optical orientation
2025-01-31	Updated order code, added order code chart w/available options
2025-02-25	Updated storage temperature for L1.9
2025-02-28	Removed sensitivity, CLK and analog output from common specifications
2025-03-18	Corrected Field of View for L1.6, L2.85 and L4.0; changed F-Number for L2.85 from 0.92 to 1
2025-04-14	Corrected pin allocations
2025-08-18	Corrected graphic for pixel orientation; adjusted graph for NETD vs Pixel Distance

2025-10-16	Added max. measurable temperature
2025-11-18	Corrected accuracy specification
2025-03-02	Added calculation formula for CLK_Trim Register

# 1 Cleaning and Handling of Sensors with Optical Elements

## Cleaning of Filter with Isopropyl Alcohol or Acetone

This is the method most universally used for cleaning optical elements with or without coatings. Filters or lenses mounted in our sensors may be cleaned rubbing the surfaces lightly with a clean, soft, all-cotton cloth or cotton swab during immersion in solvent or simply moistened with the solvent. The parts are then immediately wiped dry with another clean, soft, all-cotton cloth or cotton swab.

## Cleaning with Detergent and Water

A very mild, non-abrasive detergent (one which does not contain additives) and water may also be used for cleaning optical elements. In general, a detergent and water mixture is an excellent method for removing fingerprints and other smudges. The liquid detergent is first mixed with deionized water (proportions recommended by the manufacturer should be followed). The element is then washed, rinsed, and immediately wiped dry. Use a clean, soft cloth when cleaning and drying. If the part is allowed to dry in air, a permanent stain may result.

Please note:

- Do not use isopropyl alcohol or acetone or detergent if the elements will be mounted in an assembly with a finish, which may be soluble by these solvents.
- Please avoid glass isolation being moistened by solvent.
- If the part is allowed to dry in air, a permanent stain may result.

## Handling Advice

Sensors with optical elements deserve special consideration in their handling and care. Ordinarily, filters or lenses are cleaned and inspected prior to shipment. If proper care is exercised during handling cleaning should not be necessary prior to use.

- Wear gloves when handling a sensor or optical element. Lightweight nylon or cotton gloves which are relatively lint-free are recommended.
- Avoid touching the surface of filters and lenses.
- Protect devices from static discharge and static fields.
- Thermopile sensors are electrostatic sensitive devices. Sensors should be handled over an electrostatic protected work area.
- Precautions should be taken to avoid reverse polarity of power supply for sensors with integrated signal processing. Reversed polarity of power supply results in a destroyed unit.
- Sensors should rest preferably in a partitioned container, where the mounted filters or lenses will be not coming into contact with other material.
- During storage optical surfaces should be covered to avoid contamination from the surrounding environment.

- A covered container can eliminate damage during transportation and storage.
- Sensors or optical elements should be stored in a restricted access area to eliminate handling.
- Do not expose the sensors to aggressive detergents such as freon, trichlorethylen, etc.
- Avoid rotating the sensors when they are soldered into a PCB or something similar.
- Shortening of the pins is not suggested. This may cause cracks in the glass of the pins and result in a leakage.
- If this is necessary, a tool for this is recommended. Please contact Heimann Sensor for further information.

### Soldering Recommendations

**Attention:** For all of our array sensors we give no guarantee on the calibration and its performance, if the pins are shortened by the customer. Additionally, **we strongly recommend to not solder the sensor with its back plate directly to a PCB.** This will cause different thermal conductivity compared to air and the measurement results could get worse. **Use a minimum gap between PCB and backplate of 2 mm or more.** The glass of the pins to the back plate can get damage by applying high temperatures (during soldering), which will lead into a lower temperature reading, what cannot be repaired afterwards.

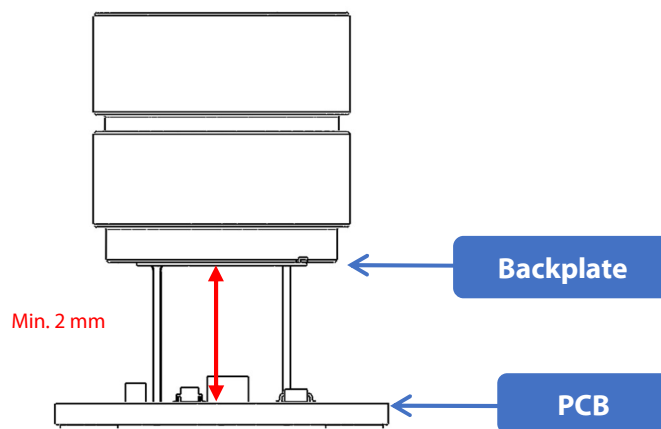

Figure 1: Soldering height

### Manual Iron Soldering and Automatic Point-to-Point Iron Soldering

Manual Iron Soldering and Automatic Point-to-Point Iron Soldering methods are allowed for TO packages. It is recommended for through hole applications to shield the package body from soldering heat by PCB or similar.

The soldering iron temperature should be set as low as possible (maximum 350 °C) and should not exceed recommended soldering time (maximum 3 seconds). The minimum distance between the housing body and the liquid solder should be at least 1.5 mm for 350 °C. Reflow soldering is not recommended.

## 2 Principal Schematic for HTPA32x32d

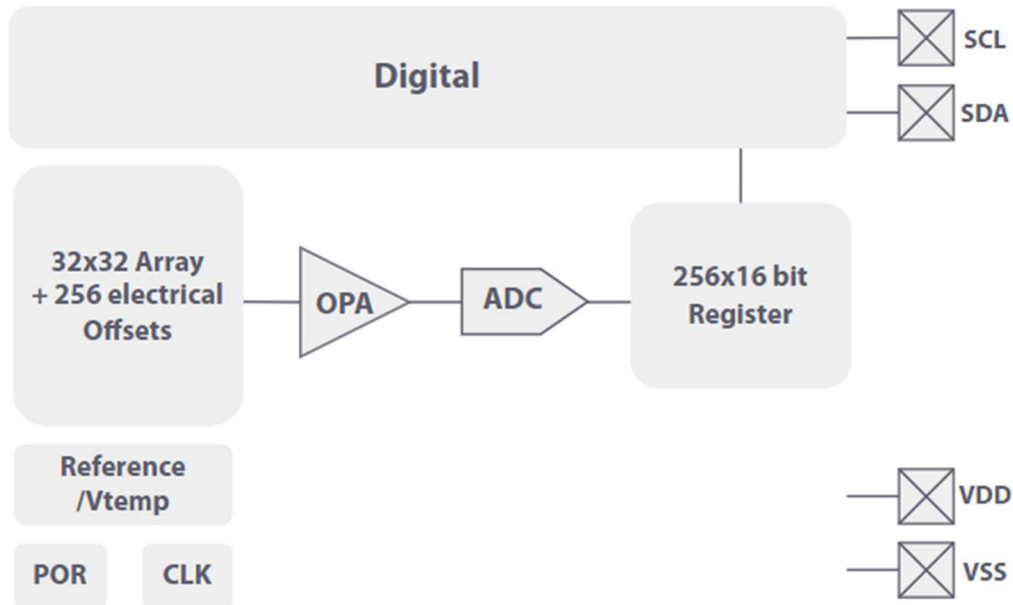

## 3 Pin Assignment–Bottom View

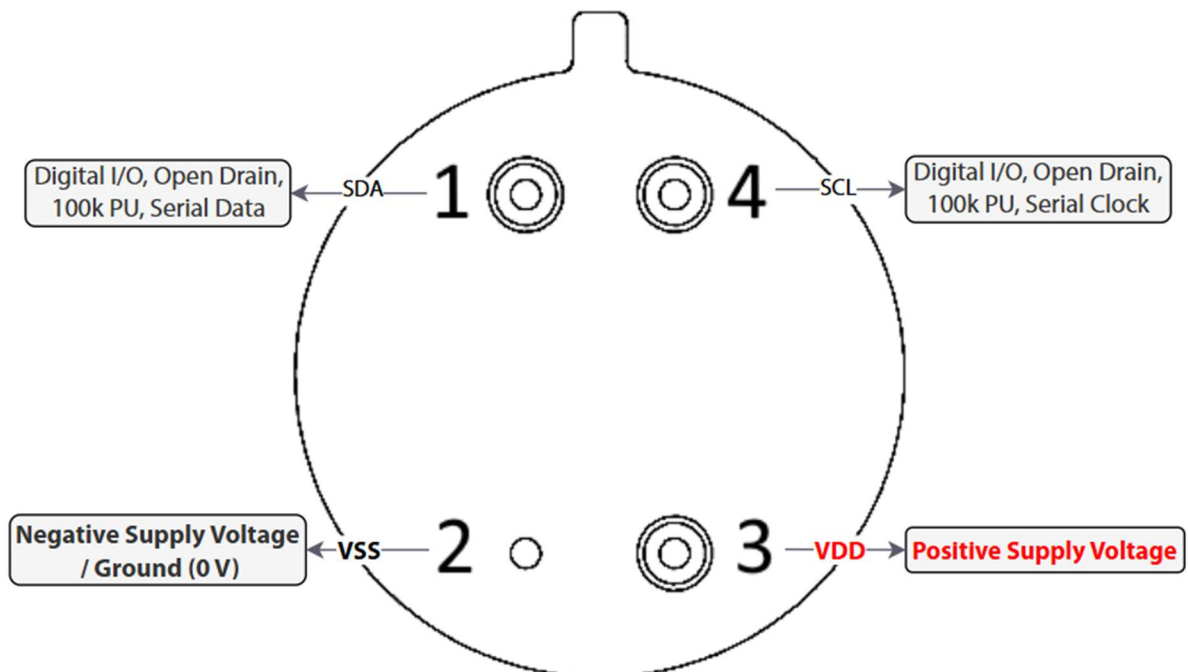
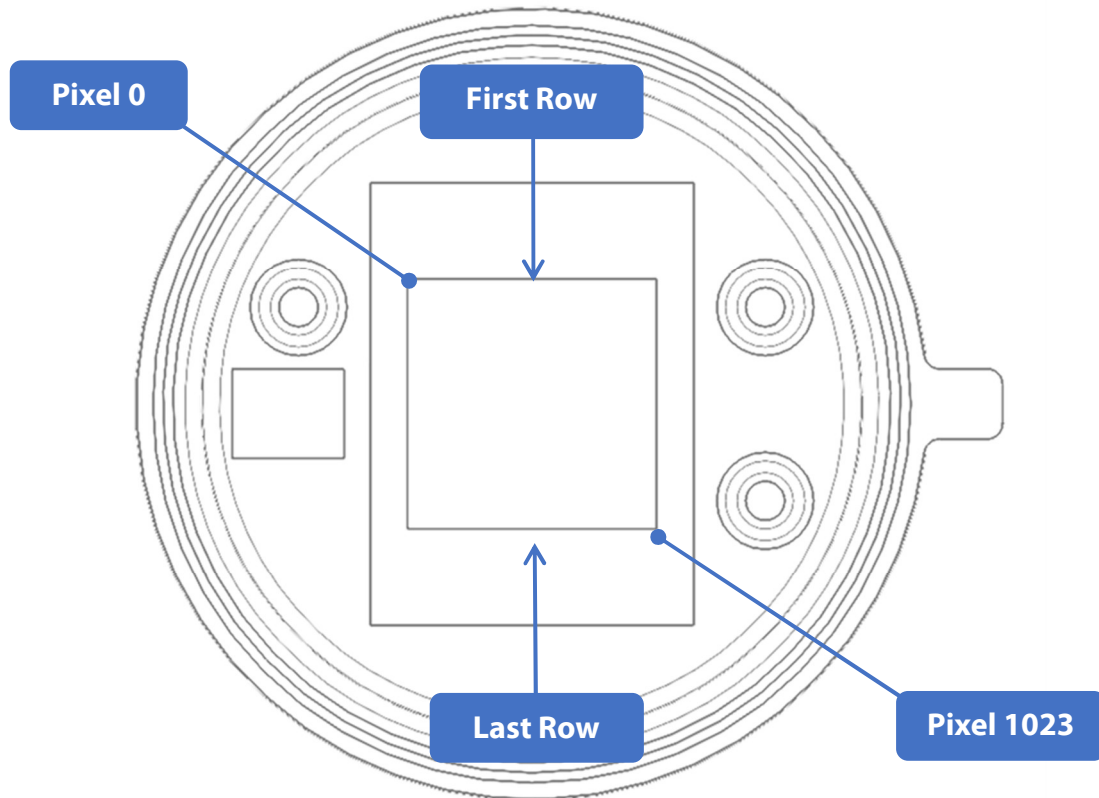
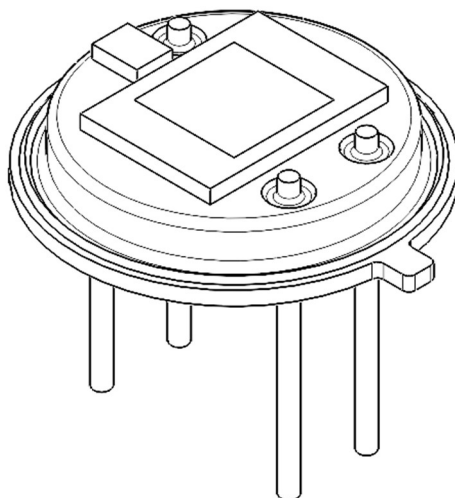

Figure 2: Pin-allocation

## 4 Optical Orientation



This illustration shows the pixel orientation after mirroring through the lens.



## 5 Order Code Example

HTPA32x32d	R2	L5.0/0.85	F7.7	e	Hi	M	(UDP)
1	2	3	4	5	6	7	8

		Description
1	Sensor Type	TP Array with 32x32 Pixel  For all available HTPA and module combinations contact our support
2	Revision	Silicon revision 2
3	Optics	Focal length/F-Number  Focal length: L5.0 = 5.0 mm F-Number: 0.85
4	Filter	F: Filter characteristics Not declared: Broadband AR Coating
5	External Aperture	Not declared: without external aperture e: with external aperture
6	Sensitivity	UHi: increased sensitivity Hi: default sensitivity Not declared: lower sensitivity (greater measurement range)
7	Version	A: Application Set: comes with GUI, housing, power supply C: Calibrated sensor M: Modul: HTPA sensor soldered to PCB, calibrated stream
8	Interface	UDP: Ethernet connection, CAT5 PoE: Power over Ethernet, CAT5* i <sup>2</sup> C: 4 Pin Connector* USB: Power and data via USB 2.0**  * Interface option is only available for modules (HiM) ** Interface option is only available for Application Set (HiA)

## 6 Application Note

A pull-up resistor of 4.7 k $\Omega$  for the I<sup>2</sup>C pins (SDA and SCL) is recommended. In addition, adding 100 nF and 47  $\mu$ F are improving the stability of the supply voltage.

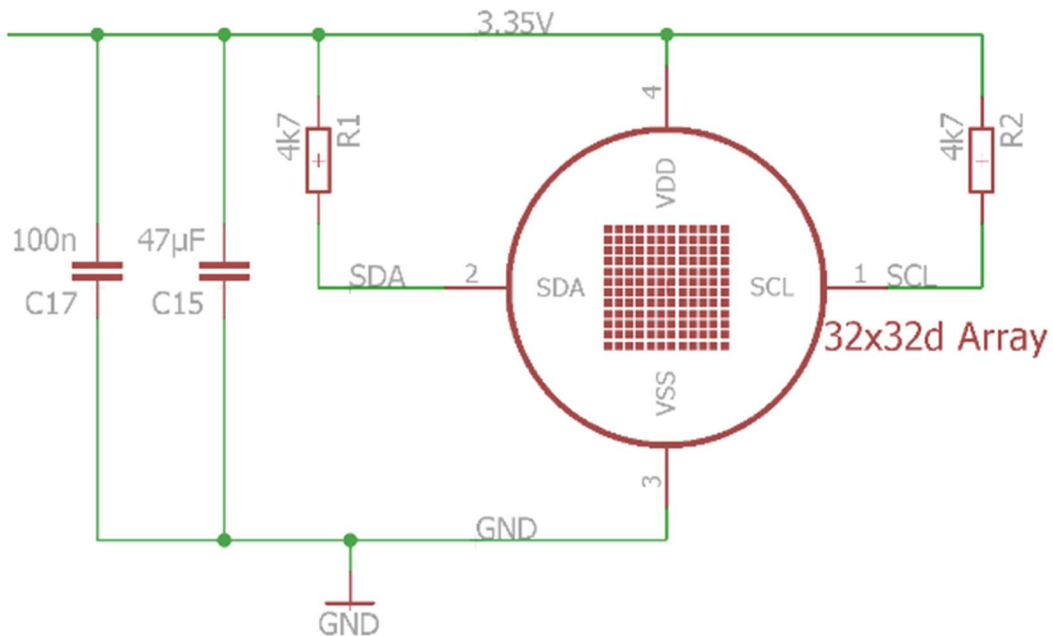

Figure 3: Recommended circuit for operation

The sensor can be powered directly via 3.35 V, if the supply voltage is stable enough, this has to be measured before and tested with the sensor. It is important to not insert any inductor or otherwise the noise will increase.

## 7 Serial Order of Frame

The sensor is divided into two parts (top and bottom half), which are again separated into 4 blocks. The readout order is shown below for the different blocks.

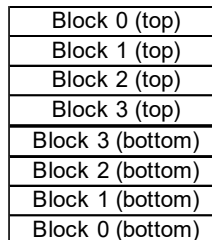

Figure 4: Division of blocks

Whenever a conversion is started, the Block x of the top and bottom half are measured at the same time. Each block consists of 128 Pixel that are sampled fully parallel. The readout order on the bottom half is mirrored compared to the top half so that the central lines are always read last.

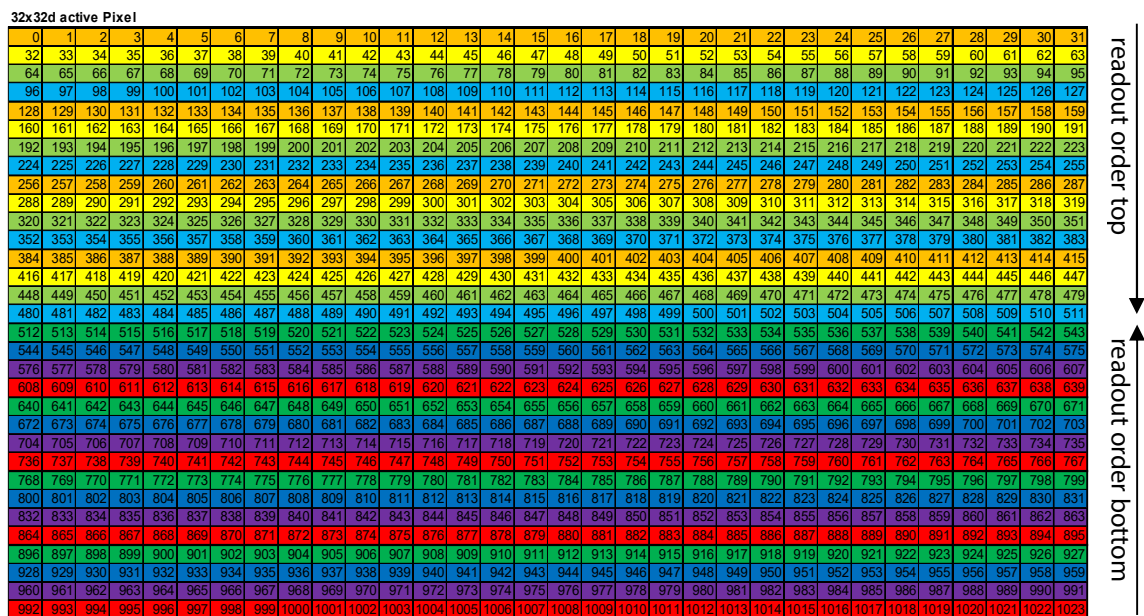

Figure 5: 32x32d readout order for active pixel

The electrical offsets are sampled in parallel for the top and bottom half. The matching rows for the corresponding electrical offsets and active Pixel are marked with the same color. The conversion of the electrical offsets is started by sending the command for the BLIND bit during the start command.

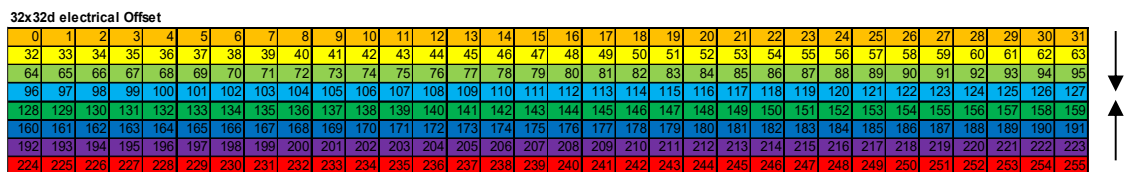

Figure 6: 32x32d readout order for electrical offset

## 8 Characteristics

### 8.1 Common Specifications

Technology:	n-poly/p-poly Si
Element Resistance:	approx. 300 kOhms
Thermal pixel time constant:	<4 ms
Digital Interface:	I <sup>2</sup> C
EEPROM size:	64 kBit
Pitch:	90 μm
Absorber size:	44 μm
Max. Framerate:	60 Hz
Max. measurable temperature:	700°C with default settings
(complete frame with maximum I <sup>2</sup> C and sensor clock speed and reduced ADC resolution)	

### 8.2 Optical Characteristics

Focal length:	1.6 mm ("L" equals the focal length of the lens)
F-Number:	0.8
Field of view:	105 x 105 deg (50% sensitivity FoV)

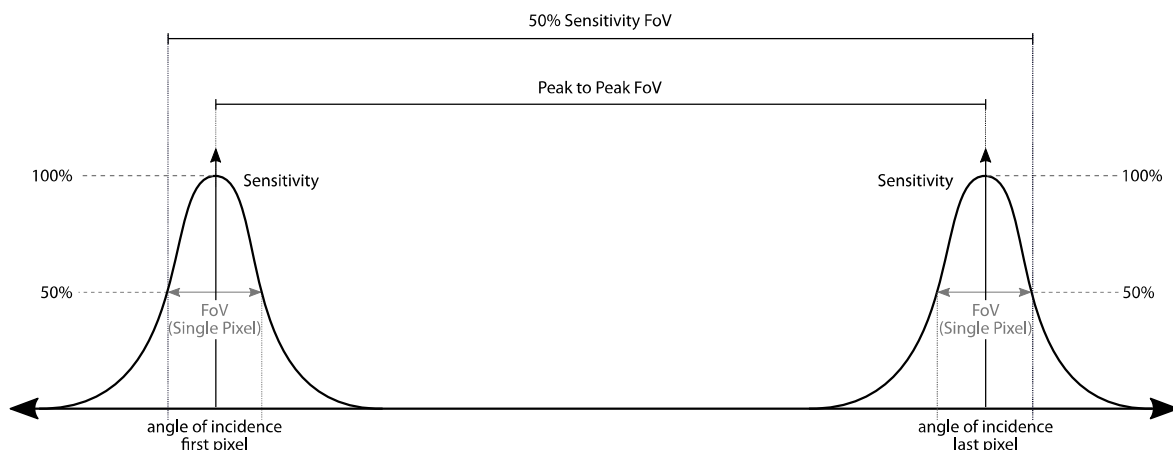

Lens coating:	LWP-Coating 5.0 Cut On (Tr. 5 %): 5.0 μm
---------------	---

Accuracy:	±3 % or ±3 K (whichever is larger) in the working ambient temperature range of 5° to 50 °C and object temperatures ≤ to 300 °C
-----------	--

The radiometric radius is specified for pixels listed below with a "1". All pixels outside this area can have a higher tolerance and less accuracy.

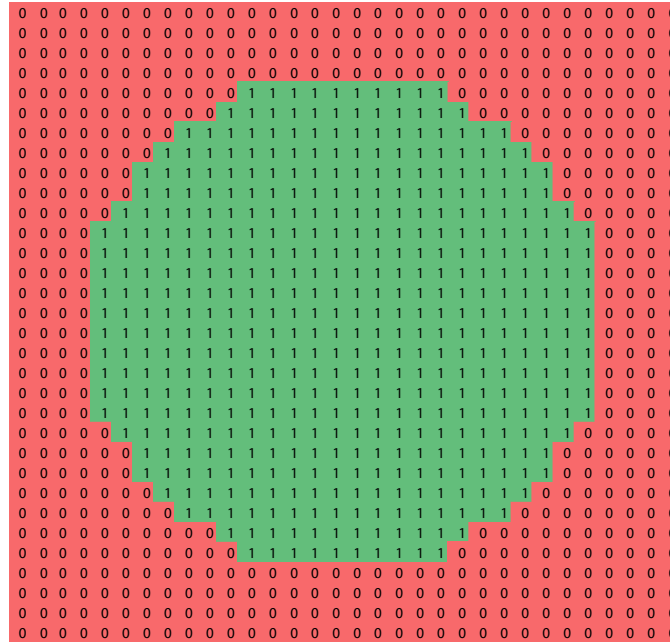

Figure 7: Radiometric radius in a matrix of 32x32 pixels

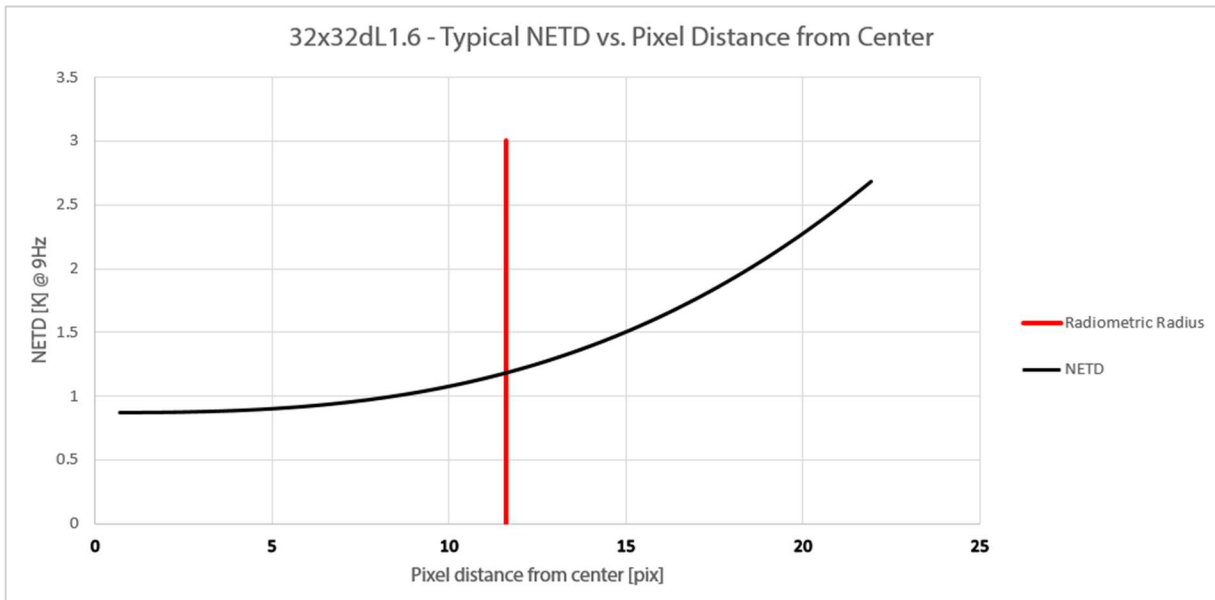

Figure 8: NETD vs Pixel distance

## 9 Electric Specifications

Table 1: Absolute Maximum Ratings

Parameter	Symbol	Condition	MIN.	TYP.	MAX.	Unit
Supply Voltage	$V_{DD}$		-0.3		3.6	V
Voltage at All inputs and outputs	$V_{IO}$		-0.3		$V_{DD}+0.3$	V
Storage Temperature	$T_{STG}$		-40		85	Deg. C

Table 2: Operating Conditions

Parameter	Symbol	Condition	MIN.	TYP.	MAX.	Unit
Supply Voltage	$V_{DD}$		3.3	3.35	3.6	V
Supply Current (sensor running)	$I_{DD}$		5.0	6.2	7.4	mA
Supply Current (sensor in idle state)	$I_{DD}$		4.5	5.8	7.15	mA
Standby Current (sensor in sleep state)	$I_{SBY}$		7	9	11	$\mu$ A
Operation Temperature	$T_A$		-20		85	Deg. C
ESD-Protection		Human body model	2.0			kV
		100pF + 1k50hm				

Table 3: Electrical Characteristics

Parameter	Symbol	Condition	MIN.	TYP.	MAX.	Unit
Digital Input						
Internal Clock frequency	$F_{CLK}$		1	5	13	MHz
Internal I <sup>2</sup> C Pull up	$R_{PU}$		1	100	100	kOhm
BIAS current	$I_{BIAS}$		1	3	13	$\mu$ A
BPA current	$I_{BPA}$		0.2	1.5	4.0	$\mu$ A
Input voltage high	$V_{IH}$		$0.7 \times V_{DD}$			V
Input voltage low	$V_{IL}$				$0.3 \times V_{DD}$	V
PTAT						
Temperature range			TBD		TBD	Deg. C
PTAT gradient			328	339	350	K/V

Table 4: Preamplifier / ADC

Parameter	Symbol	Condition	MIN.	TYP.	MAX.	Unit
<b>Chopper frequency</b>	F <sub>CHP</sub>			20		kHz
<b>Preamplifier Noise</b>	N <sub>PA</sub>	at 20 kHz		72		nV/HZ <sup>1/2</sup>
<b>Frame rate (Full Array)</b>	FR1		2	9	60	Hz
<b>Frame rate (Quarter Array)</b>	FR4		8	36	240	HZ
<b>ADC pos. Reference</b>	V <sub>REFP</sub>	REF_CAL 00		1.529		V
		REF_CAL 01		1.442		
		REF_CAL 10		1.355		
		REF_CAL 11		1.268		
<b>ADC neg. Reference</b>	V <sub>REFN</sub>	REF_CAL 00		0.850		V
		REF_CAL 01		0.901		
		REF_CAL 10		0.968		
		REF_CAL 11		1.056		
<b>ADC resolution</b>	ADC <sub>LSB</sub>	at 16 Bit	6.5		20.7	μV

## 10 I<sup>2</sup>C Timings HTPA32x32d

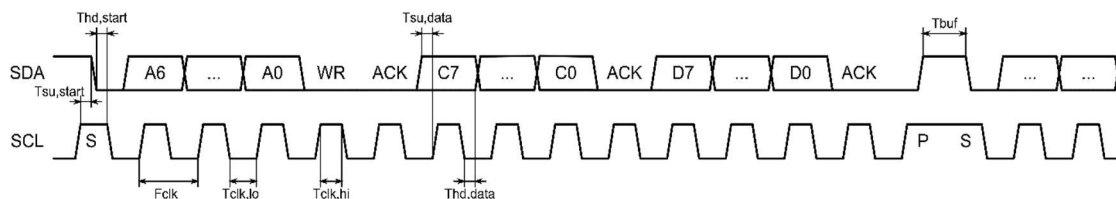

Figure 9: I<sup>2</sup>C Timings of HTPA32x32d

Table 5: I<sup>2</sup>C Timings

Parameter	Symbol	Condition	MIN.	TYP.	MAX.	Unit
<b>I<sup>2</sup>C clock frequency</b>	FCLK			400	1000	kHz
<b>low pulse duration</b>	TCLK,lo		0.50			μs
<b>high pulse duration</b>	TCLK,hi		0.26			μs
<b>data set up time</b>	TSU,data		0.05			μs
<b>data hold time</b>	Thd,data		0.00			μs
<b>start setup time</b>	TSU,start		0.26			μs
<b>start hold time</b>	Thd,start		0.26			μs
<b>stop setup time</b>	TSU,stop		0.26			μs
<b>stop hold time</b>	Thd,stop		0.26			μs
<b>time between STOP / START</b>	Tbuf		0.50			μs
<b>Time startup (after Power-on-reset)</b>	Tstartup				100	μs
<b>Wakeup time (after sending WAKEUP)</b>	Twakeup				80	μs

## 11 I<sup>2</sup>C Communication

The chip uses the **7-bit I<sup>2</sup>C address 0x1A** for configuration and **sensor** data and the **7-bit I<sup>2</sup>C address 0x50** to access the internal **EEPROM**. The address byte is followed by a W/R bit and an 8-bit command.

### 11.1 Write Command

In case of a write access to an internal register the command is followed by the data byte. The chip acknowledges each byte with a low active ACK bit.

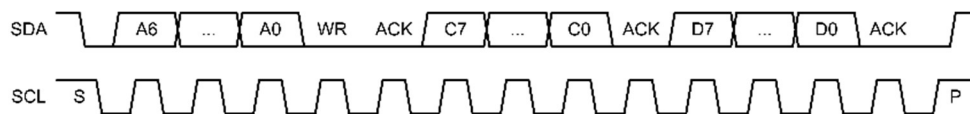

Figure 10: Write Command

### 11.2 Read Command

To read data from the chip first the address and read command must be sent. After the last ACK a new start-bit (repeated start) and the address with a set read-flag initiates the read sequence. There can be bytes read as many as required. The last byte must be denoted by a not-acknowledge. The shown example below can be used e.g. to get the status register.

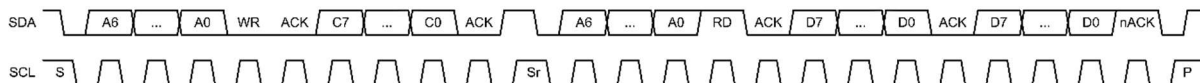

Figure 11: Read Command

### 11.3 Sensor Commands

The sensor has several registers that can be written and read, they are listed below.

Table 6: Configuration Register (write only)

Addr / CMD	0x1A (7 Bit!) / 0x01							
<b>Config Reg</b>	7	6	5	4	3	2	1	0
<b>Name</b>	RFU		BLOCK		START	VDD_MEAS	BLIND	WAKEUP
<b>Default</b>	0	0	0	0	0	0	0	0

The WAKEUP bit is used to switch on / off the chip and must be set prior all other operations. After the START bit is set the chip starts a conversion of the array or blind elements and enters the idle state (not sleep!), when finished. The BLOCK selects one of the four multiplexed array blocks.

If the BLIND bit is set the electrical offsets are sampled instead of the active pixel and the setting of the BLOCK is ignored.

If VDD\_MEAS bit is set the VDD voltage is measured instead of the PTAT value.

RFU means reserved for future use and can be subject to change.

Table 7: Status Register (read only)

Addr / CMD	0x1A (7 Bit!) / 0x02							
<b>Status Reg</b>	7	6	5	4	3	2	1	0
<b>Name</b>	RFU		BLOCK		RFU	VDD_MEAS	BLIND	EOC

If the EOC flag is set a previous started conversion has been finished.

Table 8: Trim Register 1 (write only)

Addr / CMD	0x1A (7 Bit!) / 0x03							
<b>Trim Reg 1</b>	7	6	5	4	3	2	1	0
<b>Name</b>	RFU		REF_CAL		MBIT TRIM			

REF\_CAL: selectable amplification

MBIT\_TRIM:  $m = 4$  to  $12 \Rightarrow (m+4)$  bit as ADC resolution

Table 9: Trim Register 2 (write only)

Addr / CMD	0x1A (7 Bit!) / 0x04							
<b>Trim Reg 2</b>	7	6	5	4	3	2	1	0
<b>Name</b>	RFU			BIAS TRIM TOP				

BIAS\_TRIM\_TOP: 0 to 31  $\Rightarrow 1 \mu\text{A}$  to  $13 \mu\text{A}$

This setting is used to adjust the BIAS current of the ADC. A faster clock frequency requires a higher BIAS current setting.

Table 10: Trim Register 3 (write only)

Addr / CMD	0x1A (7 Bit!) / 0x05							
<b>Trim Reg 3</b>	7	6	5	4	3	2	1	0
<b>Name</b>	RFU			BIAS TRIM BOT				

BIAS\_TRIM\_BOT: 0 to 31  $\Rightarrow 1 \mu\text{A}$  to  $13 \mu\text{A}$

This setting is used to adjust the BIAS current of the ADC. A faster clock frequency requires a higher BIAS current setting.

Table 11: Trim Register 4 (write only)

Addr / CMD	0x1A (7 Bit!) / 0x06							
<b>Trim Reg 4</b>	7	6	5	4	3	2	1	0
<b>Name</b>	RFU		CLK TRIM					

CLK\_TRIM ranges from 0 to 63 and corresponds the clock frequency  $F_{CLK}$  which can be determined via the following formula:

$$F_{CLK} = \left( F_{CLK,min} + \frac{F_{CLK,max} - F_{CLK,min}}{63} \cdot \text{CLK\_TRIM} \right) \text{MHz}$$

with

$$F_{CLK,min} = 1 \text{ MHz}$$

$$F_{CLK,max} = 13 \text{ MHz}$$

The measure time depends on the clock frequency settings. One quarter frame takes about:

$$t_{fr4} = \frac{32 \cdot (2^{MBIT} + 4)}{F_{CLK}} \approx 27 \text{ms@5MHz}$$

*MBIT* is equal to MBIT TRIM in Table 8.

Table 12: Trim Register 5 (write only)

Addr / CMD	0x1A (7 Bit!) / 0x07							
Trim Reg 5	7	6	5	4	3	2	1	0
Name	RFU			BPA TRIM TOP				

BPA\_TRIM\_TOP: 0 to 31 ⇒ 0.2 µA to 4.0 µA

This setting is used to adjust the common mode current of the preamplifier.

Table 13: Trim Register 6 (write only)

Addr / CMD	0x1A (7 Bit!) / 0x08							
Trim Reg 6	7	6	5	4	3	2	1	0
Name	RFU			BPA TRIM BOT				

BPA\_TRIM\_BOT: 0 to 31 ⇒ 0.2 µA to 4.0 µA

This setting is used to adjust the common mode current of the preamplifier.

Table 14: Trim Register 7 (write only)

Addr / CMD	0x1A (7 Bit!) / 0x09							
Trim Reg 7	7	6	5	4	3	2	1	0
Name	PU SDA TRIM				PU SCL TRIM			

PU\_SDA\_TRIM: select internal pull up resistor on SDA  
 PU\_SCL\_TRIM: select internal pull up resistor on SCL

“1000” = 100 kOhm; “0100” = 50 kOhm; “0010” = 10 kOhm; “0001” = 1 kOhm

Table 15: Read Data 1 Command (Top Half of Array)

Addr / CMD	0x1A (7 Bit!) / 0x0A							
Read Data	7	6	5	4	3	2	1	0
1. Byte / 2. Byte	PTAT 1 MSB / LSB or Vdd 1 MSB / LSB							
3. Byte / 4. Byte	Pixel (0+BLOCK*128) MSB / LSB							
5. Byte / 6. Byte	Pixel (1+BLOCK*128) MSB / LSB							
...	...							
257. Byte / 258. Byte	Pixel (127+BLOCK*128) MSB / LSB							

Table 16: Read Data 2 Command (Bottom Half of Array)

Addr / CMD	0x1A (7 Bit!) / 0x0B							
Read Data	7	6	5	4	3	2	1	0
1. Byte / 2. Byte	PTAT 2 MSB / LSB or Vdd 2 MSB / LSB							
3. Byte / 4. Byte	Pixel (992-BLOCK*128) MSB / LSB							
5. Byte / 6. Byte	Pixel (993-BLOCK*128) MSB / LSB							
...	...							
65. Byte / 66. Byte	Pixel (1023-BLOCK*128) MSB / LSB							
67. Byte / 68. Byte	Pixel (960-BLOCK*128) MSB / LSB							
69. Byte / 70. Byte	Pixel (961-BLOCK*128) MSB / LSB							
...	...							
129. Byte / 130. Byte	Pixel (991-BLOCK*128) MSB / LSB							
131. Byte / 132. Byte	Pixel (928-BLOCK*128) MSB / LSB							

...	
<b>257. Byte / 258. Byte</b>	Pixel (927-BLOCK*128) MSB / LSB

The complete sensor data must be read at once. If the communication fails somewhere in between, all successive data will be corrupted. The readout can be stopped anywhere by pausing the clock. A new initialized readout proceeds at this stopped byte by continuing the clock, but the index is reset when a new conversion has been started.

If the bit for the electrical offsets (Bit 1 in Config 0x01) is set the electrical offsets are sampled and can be read similar to the active pixel:

Table 17: Read Data Electrical Offsets (Top Half of Array)

Addr / CMD	0x1A (7 Bit!) / 0x0A							
Read Data	7	6	5	4	3	2	1	0
<b>1. Byte / 2. Byte</b>	PTAT 1 MSB / LSB or Vdd 1 MSB / LSB							
<b>3. Byte / 4. Byte</b>	electrical offset (0) MSB / LSB							
<b>5. Byte / 6. Byte</b>	electrical offset (1) MSB / LSB							
...	...							
<b>257. Byte / 258. Byte</b>	electrical offset (127) MSB / LSB							

Table 18: Read Data Electrical Offsets (Bottom Half of Array)

Addr / CMD	0x1A (7 Bit!) / 0x0B							
Read Data	7	6	5	4	3	2	1	0
<b>1. Byte / 2. Byte</b>	PTAT 2 MSB / LSB or Vdd 2 MSB / LSB							
<b>3. Byte / 4. Byte</b>	electrical offset (224) MSB / LSB							
<b>5. Byte / 6. Byte</b>	electrical offset (225) MSB / LSB							
...	...							
<b>65. Byte / 66. Byte</b>	electrical offset (255) MSB / LSB							
<b>67. Byte / 68. Byte</b>	electrical offset (192) MSB / LSB							
...	...							
<b>257. Byte / 258. Byte</b>	electrical offset (159) MSB / LSB							

The complete sensor data must be read at once. If the communication fails somewhere in between, all successive data will be corrupted. The readout can be stopped anywhere by pausing the clock. A new initialized readout proceeds at this stopped byte by continuing the clock, but the index is reset when a new conversion has been started.

Depending on the setting of VDD\_MEAS the PTAT or the VDD is transmitted.

## 11.4 EEPROM Communication

The built-in EEPROM (24AA64 from Microchip) consists of 8 blocks of 1K x 8-bit. The chip select of the EEPROM is set to 000 (A2 to A0). For further information, please see the corresponding datasheet:

[www.microchip.com](http://www.microchip.com)

## 11.5 I<sup>2</sup>C Example Sequences – Init and Read Thermopile Array

(There should be a delay of at least 5 ms between the write of each Configuration Register)

Please be reminded, that you readout the calibration settings for MBIT, BIAS, CLK, BPA and PU and use them for a correct temperature calculation.

	ADDR	W/R	CONFIG_REG	WAKEUP	
S	0x1A	0	0x01	0x01	P

	ADDR	W/R	TRIM_REG1	MBIT_TRIM	
S	0x1A	0	0x03	0x0C	P

	ADDR	W/R	TRIM_REG2	BIAS_TRIML	
S	0x1A	0	0x04	0x0C	P

	ADDR	W/R	TRIM_REG3	BIAS_TRIMR	
S	0x1A	0	0x05	0x0C	P

	ADDR	W/R	TRIM_REG4	CLK_TRIM	
S	0x1A	0	0x06	0x14	P

	ADDR	W/R	TRIM_REG5	BPA_TRIML	
S	0x1A	0	0x07	0x0C	P

	ADDR	W/R	TRIM_REG6	BPA_TRIMR	
S	0x1A	0	0x08	0x0C	P

	ADDR	W/R	TRIM_REG7	PU_TRIM	
S	0x1A	0	0x09	0x88	P

	ADDR	W/R	CONFIG_REG	START WAKEUP	
S	0x1A	0	0x01	0x09	P

	ADDR	W/R	STATUS_REG		ADDR	W/R	STATUS	
S	0x1A	0	0x02	Sr	0x1A	1	??	P

Wait 30 ms

	ADDR	W/R	STATUS_REG		ADDR	W/R	STATUS	
S	0x1A	0	0x02	Sr	0x1A	1	??	P

	ADDR	W/R	READ_DATA 1		ADDR	W/R	PTAT1_MSB	PTAT1_LSB	P0,0_MSB	P0,0_LSB	...	Px,y_MSB	Px,y_LSB	
S	0x1A	0	0x0A	Sr	0x1A	1	??	??	??	??	...	??	??	P

	ADDR	W/R	READ_DATA 2		ADDR	W/R	PTAT2_MSB	PTAT2_LSB	P0,0_MSB	P0,0_LSB	...	Px,y_MSB	Px,y_LSB	
S	0x1A	0	0x0B	Sr	0x1A	1	??	??	??	??	...	??	??	P

	ADDR	W/R	CONFIG_REG	SLEEP	
S	0x1A	0	0x01	0x00	P

## 12 Temperature Calculation

The object and ambient temperature can be calculated from the sensor output and the stored calibration data. The table below is showing an overview of the EEPROM.

32x32d	0x00	0x01	0x02	0x03	0x04	0x05	0x06	0x07	0x08	0x09	0x0A	0x0B	0x0C	0x0D	0x0E	0x0F
0x0000	PixCmin (float)			PixCmax (float)			gradScale		TN as 16 bit unsigned		epsilon					
0x0010			Arraytype		VDDTH1		VDDTH2		MBIT(calib)		BIAS(calib)		CLK(calib)		PU(calib)	
0x0020					PTAT-gradient (float)			PTAT-offset (float)			PTAT (Th1)		PTAT (Th2)			
0x0030											VddScGrad		VddScOff			
0x0040					GlobalOff		GlobalGain									
0x0050					GlobalOff		GlobalGain									
0x0060	MBIT(user)		BIAS(user)		CLK(user)		BPA(user)		PU(user)							
0x0070					DeviceID										NrOfDefPix	
0x0080	DeadPixAdr as 16 bit unsigned values															
0x0090	DeadPixMask															
0x00A0	DeadPixMask															
0x00B0	free to use															
0x00C0	free to use															
0x00D0	free to use															
...																
0x0330	VddCompGrad <sub>i</sub> stored as 16 bit signed values															
0x0340	VddCompGrad <sub>i</sub> stored as 16 bit signed values															
...																
0x0530	VddCompOff <sub>i</sub> stored as 16 bit signed values															
0x0540	VddCompOff <sub>i</sub> stored as 16 bit signed values															
...																
0x0730	ThGrad <sub>i</sub> stored as 16 bit signed values															
0x0740	ThGrad <sub>i</sub> stored as 16 bit signed values															
...																
0x0F30	ThOffSet <sub>i</sub> stored as 16 bit signed values															
0x0F40	ThOffSet <sub>i</sub> stored as 16 bit signed values															
...																
0x1730	P <sub>i</sub> stored as 16 bit unsigned values															
0x1740	P <sub>i</sub> stored as 16 bit unsigned values															
...																
0x1F30																

Figure 12: EEPROM Overview 32x32d

All values are stored as unsigned 8-bit values unless they are specified otherwise. The little endian format is used for larger values. Grey marked areas are used during calibration or for future use and are Heimann Sensor reserved.

MBIT(calib), BIAS(calib), CLK(calib), BPA(calib) and PU(calib) are the settings for the registers, that have been used during calibration.

**We recommend the usage of calibration settings of MBIT (stored in 0x1A), BIAS (0x1B), CLK (0x1c), BPA (0x1D) and PU (0x1E).**

MBIT(user), BIAS(user), CLK(user), BPA(user) and PU(user) are free to be set by the user.

**The temperature calculation is only valid, if the same settings are used that have been set during calibration!**

TN is the table number and has to match the given table number in the sample code.

GlobalOff is stored as an 8-bit signed value, GlobalGain and VddCalib are both stored as 16 bit unsigned.

VDDTH1 and VDDTH2 is the used supply voltage during calibration measured by the sensor itself and stored in Digits.

The corresponding order of  $ThGrad_{ij}$ ,  $ThOffset_{ij}$  and  $P_{ij}$  to the Pixel number is given by the following overview:

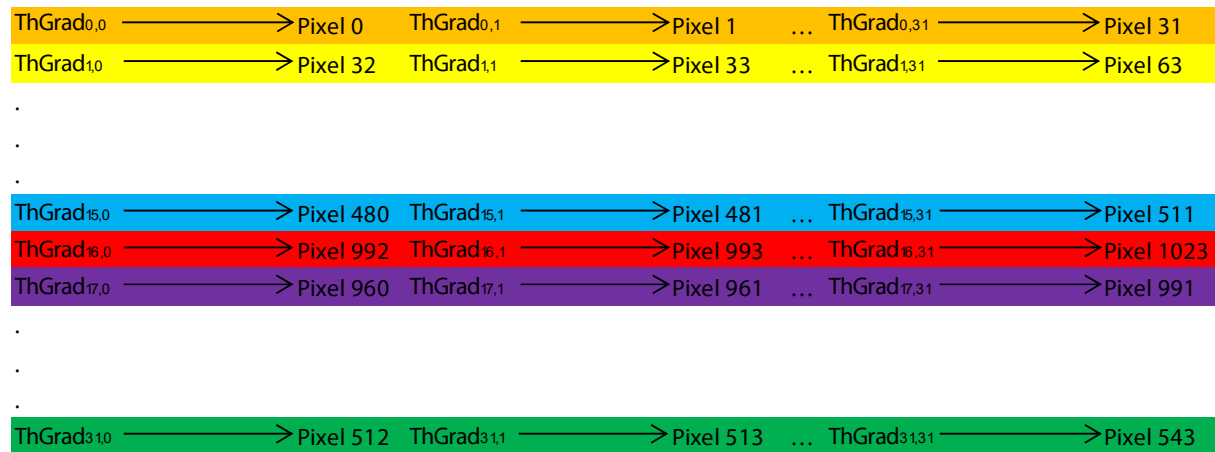

Figure 13: Readout Order 32x32d

The order of  $VddCompGrad_{ij}$  and  $VddCompOff_{ij}$  is similar to the electrical Offsets and have to be used block by block.

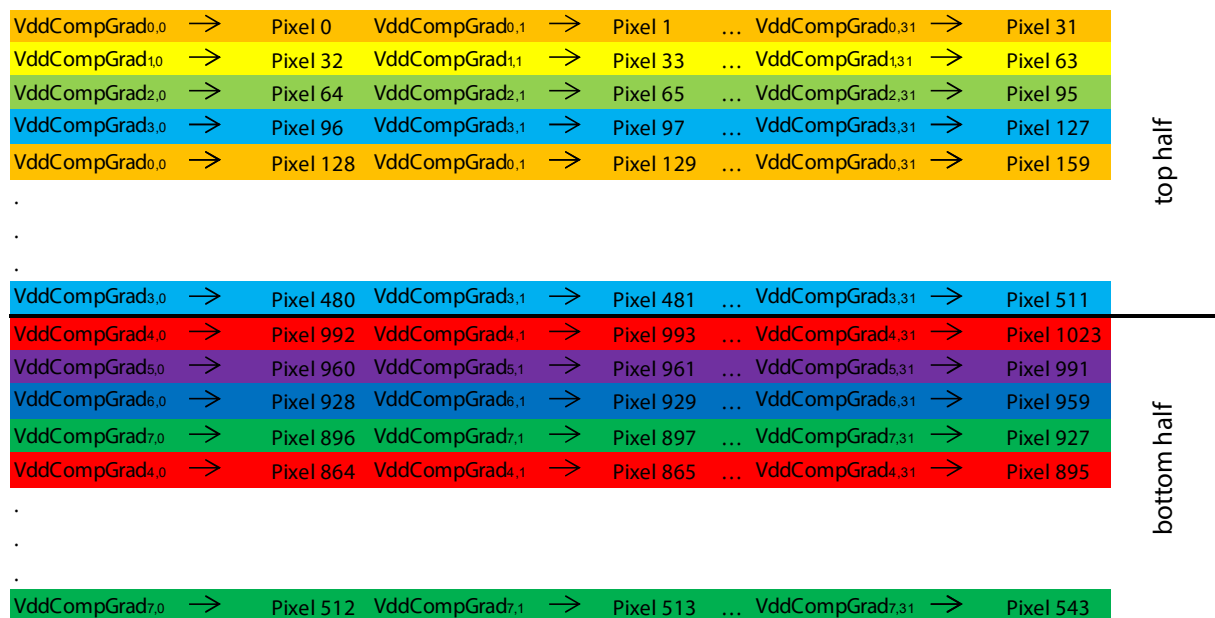

Figure 14: Readout of VDDCompGrad 32x32d

The order for DeadPixAdr\_Pij is described more detailed in 13.1.

## 12.1 Ambient Temperature

The ambient temperature ( $T_a$ ) is calculated from the average measured PTAT value, the  $PTAT_{gradient}$  and the  $PTAT_{offset}$ . It is recommended to use a stack buffer for the PTAT values, in order to get a more stable ambient temperature result.

$$T_a = PTAT_{av} \cdot PTAT_{gradient} + PTAT_{offset} \quad (\text{Value is given back in dK})$$

where:

$PTAT_{gradient}$	is the gradient of the PTAT stored in the EEPROM as a float value
$PTAT_{offset}$	is the offset of the PTAT stored in the EEPROM as a float value
$PTAT_{av} = \frac{\sum_{i=0}^7 PTAT_i}{8}$	is the average measured PTAT value

## 12.2 Thermal Offset

The thermal offset of the sensor needs to be subtracted for each pixel to compensate for any thermal drifts.

$$V_{ij\_Comp} = V_{ij} - \frac{ThGrad_{ij} \cdot PTAT_{av}}{2^{gradScale}} - ThOffset_{ij}$$

where:

$ij$	represents the row (i) and column (j) of the pixel
$V_{ij\_Comp}$	is the thermal offset compensated voltage
$V_{ij}$	is the raw pixel data (digital), readout from the RAM
$ThGrad_{ij}$	is the thermal gradient, stored in the EEPROM from 0x740 to 0xF3F
$ThOffset_{ij}$	is the thermal offset, stored in the EEPROM from 0xF40 to 0x17F
$gradScale$	is the scaling coefficient for the thermal gradient stored in the EEPROM

## 12.3 Electrical Offset

The electrical offset is used to compensate changes in the supply voltage. This compensation is only a subtraction so it can be done before or after the thermal offset compensation (here done afterwards). It is recommended to use an electrical offset stack in order to get a more stable electrical offset result and a more stable temperature result at the end. The electrical offsets should be sampled every 8<sup>th</sup> to 10<sup>th</sup> frame.

The compensation for the top half is done by using the following formula:

$$V_{ij\_Comp} * = V_{ij\_Comp} - elOffset[(j + i \cdot 32) \% 128]$$

and the bottom half analogue with this formula:

$$V_{ij\_Comp} * = V_{ij\_Comp} - elOffset[(j + i \cdot 32)\%128 + 128]$$

where:

$ij$	represents the row (i) and column (j) of the pixel and electrical offset
$V_{ij\_Comp} *$	is the thermal and electrical offset compensated voltage
$V_{ij\_Comp}$	is the thermal offset compensated voltage
$elOffset_{ij}$	is the electrical offset belonging to Pixel ij
$i\%128$	is the rest of the integer division of i by 128 (e.g. $130\%128=2$ )

## 12.4 Vdd Compensation

A supply voltage compensation called VddComp is used to take care of supply voltage changes. In order to use this compensation the supply voltage of the sensor (Vdd) has to be measured by the sensor from time to time by setting the configuration register and the average of Vdd 1 and Vdd 2 is resulting in Vdd (similar like  $PTAT_{av}$ ). It is recommended to use a VDD stack buffer in order to get a more stable VDD value. The stack should be similar to the PTAT stack.

The compensation for the top half is done by using the following formula:

$$VDD_{av} = \frac{\sum_{i=0}^7 VDD_i}{8}$$

$$V_{ijVDDComp} = V_{ijComp} *$$

$$\frac{\left( \frac{VddCompGrad[(j + i \cdot 32)\%128] \cdot PTAT_{av}}{2^{VDDScGrad}} + VddCompOff[(j + i \cdot 32)\%128] \right)}{2^{VDDScOff}} \cdot \left( VDD_{av} - VDD_{TH1} - \left( \frac{VDD_{TH2} - VDD_{TH}}{PTAT_{TH} - PTAT_{TH1}} \right) \cdot (PTAT_{av} - PTAT_{TH1}) \right)$$

and the bottom half analogue with this formula:

$$V_{ijVDDComp} = V_{ijComp} *$$

$$\frac{\left( \frac{VddCompGrad[(j + i \cdot 32)\%128 + 128] \cdot PTAT_{av}}{2^{VDDScGrad}} + VddCompOff[(j + i \cdot 32)\%128 + 128] \right)}{2^{VDDScOff}} \cdot \left( VDD_{av} - VDD_{TH1} - \left( \frac{VDD_{TH} - VDD_{TH}}{PTAT_{TH} - PTAT_{TH}} \right) \cdot (PTAT_{av} - PTAT_{TH}) \right)$$

where:

$ij$	represents the row (i) and column (j) of the pixel
$V_{ij\_VDDComp}$	is the Vdd compensated voltage

$V_{ij\_Comp}^*$	is the thermal and electrical offset compensated voltage
$VddComGrad[ij]$	is the VddComp gradient belonging to Pixel ij
$VddComOff[ij]$	is the VddComp offset belonging to Pixel ij
$i\%128$	is the rest of the integer division of i by 128 (e.g. $130\%128=2$ )
$VDD_{av}$	is the average measured supply voltage of the sensor in Digits
$VddScGrad$	is a scaling coefficient and stored in the EEPROM 0x4E
$VddScOff$	is a scaling coefficient and stored in the EEPROM 0x4F
$VDD_{TH1}$	is the supply voltage during calibration 1 stored in the EEPROM 0x26, 0x27
$VDD_{TH2}$	is the supply voltage during calibration 2 stored in the EEPROM 0x28, 0x29
$PTAT_{TH1}$	is the PTAT value of calibration 1 stored in the EEPROM 0x3C, 0x3D
$PTAT_{TH2}$	is the PTAT value of calibration 2 stored in the EEPROM 0x3E, 0x3F

## 12.5 Object Temperature

The calculation of the object temperature is done by using a look-up table and doing a bi-linear interpolation, the matching table is given by the table number (TN). The table is supplied in a separate file named "Table.c". If you do not have the file, please ask Heimann Sensor for support.

The sensitivity coefficients ( $PixC_{ij}$ ) are calculated in the following way:

$$PixC_{ij} = \left( \frac{P_{ij} \cdot (PixC_{max} - PixC_{min})}{65535} + PixC_{min} \right) \cdot \frac{\epsilon}{100} \cdot \frac{GlobalGain}{10000}$$

where:

$PixC_{ij}$	is the sensitivity coefficient for each pixel
$P_{ij}$	is the stored sensitivity coefficient scaled to 16 bit
$PixC_{min}$	is the minimum sensitivity coefficient, used for scaling
$PixC_{max}$	is the maximum sensitivity coefficient, used for scaling
$\epsilon$	is the emissivity factor
$GlobalGain$	is a factor for fine tuning of the sensitivity for all Pixel

Leading to a compensation of the pixel voltage

$$V_{ij\_PixC} = \frac{V_{ij\_VDDComp} \cdot PCSCALEVAL}{PixC_{ij}}$$

where:

$V_{ij\_PixC}$	is the sensitivity compensated IR voltage
$PCSCALEVAL$	is a defined scaling coefficient, typically set to $1 \cdot 10^8$

## 13 Example Calculation

Example values:

$$PTAT_{av} = \frac{\sum_{i=0}^7 PTAT_i}{8} = 38152 \text{Digits}$$

$$PTAT_{gradient} = 0.0211 \text{ dK/Digit}$$

$$PTAT_{offset} = 2195.0 \text{ dK}$$

$$V_{00} = 34435 \text{ Digits}$$

$$elOffset[0] = 34240$$

$$gradScale = 17$$

$$THGrad_{00} = 87 \rightarrow \text{signcheck } 87$$

$$THOffset_{00} = 65506 \rightarrow \text{signcheck } -30$$

$$VDD_{av} = 35000$$

$$VDD_{TH} = 33942$$

$$VDD_{TH2} = 36942$$

$$PTAT_{TH1} = 30000$$

$$PTAT_{TH} = 42000$$

$$VddCompGrad[0] = 10356 \rightarrow \text{signcheck } 10356$$

$$VddCompOff[0] = 51390 \rightarrow \text{signcheck } -14146$$

$$VddScGrad = 16$$

$$VddScOff = 23$$

$$PixC_{00} = 1 \cdot 10^8$$

$$PCSCALEVAL = 1 \cdot 10^8$$

Calculation of ambient temperature:

$$Ta = PTAT_{av} \cdot PTAT_{gradient} + PTAT_{offset} = 38152 \cdot 0.0211 + 2195.0 \text{ dK} = 3000 \text{ dK}$$

Compensation of thermal offset:

$$V_{00\_Comp} = V_{00} - \frac{ThGrad_{00} \cdot PTAT_{av}}{2^{gradScale}} - ThOffset_{00} = 34435 - \frac{87 \cdot 38152}{2^{17}} - (-30) = 34439$$

Compensation of electrical offset:

$$V_{00\_Comp}^* = V_{00\_Comp} - elOffset[0] = 34439 - 34240 = 199$$

Compensation of supply voltage:

$$V_{ij\_VDDComp} = V_{ij\_Comp}^* - \frac{\left( \frac{VddCompGrad[0] \cdot PTAT_{av}}{2^{VddScGrad}} + VDDCompOff[0] \right)}{2^{VddScOff}}$$

$$\cdot \left( VDD_{av} - VDD_{Th1} - \left( \frac{VDD_{TH} - VDD_{TH1}}{PTAT_{TH2} - PTAT_{TH1}} \right) \cdot (PTAT_{av} - PTAT_{TH1}) \right)$$

$$= 199 - \frac{\left( \frac{10356 \cdot 38152}{2^{16}} - 14146 \right) \cdot (35000 - 33942 \pm 2038)}{2^{23}} = 199 - (1) = 198$$

Table 19: Example look-up table

TA[dK]/dig	2882	3032	3182	3332
-64	1494	2128	2491	2775
-32	2466	2692	2898	3091
0	2882	3032	3182	3332
32	3170	3285	3406	3530
64	3396	3491	3592	3699
96	3584	3665	3754	3848
128	3746	3818	3897	3981
160	3890	3954	4025	4102
192	4019	4078	4143	4214
224	4137	4191	4251	4317
256	4246	4296	4351	4413
288	4347	4393	4445	4503
320	4441	4485	4534	4588

$$V_{00\_PixC} = \frac{198 \cdot 1 \cdot 10^8}{1.087 \cdot 10^8} = 182$$

Ta was calculated before to 3000 dK.

The matching region in the look-up table is already marked yellow, the bi-linear interpolation is leading to an object temperature of 4026 dK = (4026dK-2732dK)/10 = 129.4 °C.

A global Offset (GlobalOff) is used for fine tuning of the measured object temperature and has to be added to the object temperature. This value is stored in the EEPROM.

### 13.1 Pixel Masking

A maximum of 5 defect Pixels are allowed on the complete array, this means that at least 99.5 % of the Pixels are working correctly. The amount of defect Pixels is given in the EEPROM at address 0x007F and is named *NrOfDefPix*. *DeadPixAdr* is the address of the defect Pixels and *DeadPixMask* determines the neighbours, that should be used for masking the pixel. A simple averaging of all selected nearest neighbours is done to overwrite the temperature value of these Pixel. Only the amount of pixels "*NrOfDefPix*" is stored in *DeadPixAdr*. These values are stored as 16 bit unsigned values. For example: If only one pixel has to be masked, then the other values of *DeadPixAdr* are set to 0.

The value stored in *DeadPixAdr* is equal to the pixel number if *DeadPixAdr* is <0x0200. If the value is greater, that means between 0d512 and 0d1024, the actual read-out pixel has to be calculated first. For example: If you have a pixel number of 997 stored to the EEPROM, this is actually 517 (please refer to 6). The pixel number, that is stored in the EEPROM corresponds to the number of the read-out pixel. So the bottom half is mirrored.

Example calculation:

$$adaptedAdr [i] = 1024 + 512 - DeadPixAdr [i] + k[i] \cdot 2 - 32$$

where:

*adaptedAdr [i]* is the adapted dead pixel address

*k[i]* is the column of the corresponsive pixel (for pixel number 997 this would be 5)

$$adaptedAdr [i] = 1024 + 512 - 997 + 10 - 32 = 517$$

The neighbours to use is given in a binary format and the order is shown in the overview below in decimal and binary values for the top and bottom half.

top half

128	1	2
64	DeadPix	4
32	16	8

0b1000 0000	0b0000 0001	0b0000 0010
0b0100 0000	DeadPix	0b0000 0100
0b0010 0000	0b0001 0000	0b0000 1000

bottom half

32	16	8
64	DeadPix	4
128	1	2

0b0010 0000	0b0001 0000	0b0000 1000
0b0100 0000	DeadPix	0b0000 0100
0b1000 0000	0b0000 0001	0b0000 0010

Example values for the masking:

$$NrOfDefPix = 0x03$$

$$DeadPixAdr[0] = 0x000F \rightarrow \text{Pixel 15}$$

$$DeadPixAdr[1] = 0x012C \rightarrow \text{Pixel 300}$$

$$DeadPixAdr[2] = 0x0295 \rightarrow \text{Pixel 661 (read - out pixel) actual pixel number is 885}$$

$$DeadPixMask[0] = 0x7C \rightarrow 0b01111100(\text{top})$$

$$DeadPixMask[1] = 0x8F \rightarrow 0b10001111(\text{top})$$

$$DeadPixMask[2] = 0xFE \rightarrow 0b11111110(\text{bot})$$

According to the sample values 3 Pixels are defect and need to be interpolated. 2 Pixels are on the top and 1 Pixel on the bottom half. Assuming, that the neighbouring Pixels are having the temperature data stated below and the green marked cells are used for averaging (according to DeadPixMask), then the interpolated temperature will be the following:

$$Pixel\ 15 = \frac{3007 + 3008 + 3008 + 3011 + 3009}{5} dK = \frac{15043}{5} dK \approx 3009dK$$

$$Pixel\ 300 = \frac{3010 + 3012 + 3005 + 3008 + 3009}{5} dK = \frac{15044}{5} dK \approx 3009dK$$

$$Pixel\ 885 = \frac{3010 + 3012 + 3005 + 3007 + 3008 + 3008 + 3009}{7} dK = \frac{21059}{7} dK \approx 3008dK$$

All values are given in dK

3007	Pixel 15	3008
3008	3011	3009

Pixel 14	Pixel 15	Pixel 16
Pixel 46	Pixel 47	Pixel 48

3010	3012	3005
3007	Pixel 300	3008
3008	3011	3009

Pixel 267	Pixel 268	Pixel 269
Pixel 299	Pixel 300	Pixel 301
Pixel 331	Pixel 332	Pixel 333

3010	3012	3005
3007	Pixel 885	3008
3008	3011	3009

Pixel 852	Pixel 853	Pixel 854
Pixel 884	Pixel 885	Pixel 886
Pixel 916	Pixel 917	Pixel 918

If a pixel is masked, the adjacent neighbours must have not more than 4 dead pixels in serial order, if you check them clockwise (or the other way around):

OK		
0	1	0
0	0	1
1	0	0

OK		
0	1	0
0	0	1
0	0	1

NOK		
0	1	1
0	0	1
0	0	0

### 13.2 Look-up Table

The matching look-up table has to be taken from the "Table.c" file. Here is just shown an exemplary data for one optic.

dig. I, Tai[°K]	2782	2882	2982	3082	3182	3282	3382	6848	6421	6431	6482	6514	6584	6673	6777
-512	0	0	0	1295	1742	2005	2202	6912	6437	6447	6478	6530	6600	6689	6794
-448	0	0	1473	1848	2094	2284	2442	6976	6453	6463	6494	6546	6616	6705	6810
-384	695	1590	1923	2156	2340	2496	2634	7040	6469	6479	6510	6562	6632	6721	6826
-320	1688	1984	2202	2381	2534	2671	2797	7104	6485	6495	6526	6577	6648	6737	6842
-256	2042	2244	2414	2562	2697	2822	2938	7168	6501	6511	6542	6593	6664	6753	6858
-192	2287	2445	2587	2717	2839	2954	3065	7232	6517	6526	6557	6608	6679	6768	6874
-128	2481	2612	2735	2852	2964	3073	3180	7296	6532	6542	6573	6624	6695	6784	6890
-64	2642	2755	2865	2972	3078	3182	3285	7360	6548	6557	6588	6640	6711	6800	6906
0	2782	2882	2982	3082	3182	3282	3382	7424	6563	6572	6603	6655	6726	6816	6922
64	2906	2996	3089	3183	3278	3375	3473	7488	6578	6588	6619	6671	6742	6832	6938
128	3019	3110	3197	3278	3368	3462	3558	7552	6594	6603	6634	6686	6757	6847	6953
192	3121	3197	3278	3363	3452	3544	3638	7616	6609	6618	6649	6701	6772	6862	6968
256	3218	3296	3363	3445	3531	3621	3715	7680	6624	6633	6664	6715	6787	6877	6984
320	3305	3370	3443	3522	3606	3695	3787	7744	6639	6648	6679	6730	6802	6892	6999
384	3387	3449	3519	3595	3677	3764	3856	7808	6654	6663	6694	6745	6817	6907	7014
448	3465	3524	3590	3664	3745	3831	3922	7872	6669	6677	6708	6759	6832	6922	7029
512	3539	3596	3659	3731	3810	3895	3986	7936	6683	6692	6723	6774	6847	6937	7044
576	3609	3662	3724	3794	3872	3957	4047	8000	6698	6707	6737	6788	6861	6952	7059
640	3676	3727	3787	3855	3932	4016	4106	8064	6712	6721	6752	6803	6876	6966	7074
704	3740	3788	3847	3914	3990	4073	4163	8128	6727	6735	6766	6817	6890	6981	7089
768	3802	3848	3904	3971	4046	4128	4215	8192	6741	6750	6780	6832	6905	6996	7104
832	3861	3905	3960	4025	4100	4182	4271	8256	6755	6764	6795	6847	6919	7010	7118
896	3918	3960	4014	4078	4152	4233	4322	8320	6770	6778	6809	6861	6933	7024	7133
960	3973	4014	4066	4129	4202	4284	4372	8384	6784	6792	6823	6875	6947	7038	7147
1024	4026	4065	4117	4179	4251	4332	4421	8448	6798	6806	6837	6889	6961	7052	7162
1088	4077	4115	4168	4227	4299	4380	4469	8512	6812	6820	6851	6903	6975	7066	7176
1152	4127	4164	4213	4274	4345	4426	4515	8576	6826	6834	6865	6917	6989	7081	7190
1216	4175	4211	4260	4320	4391	4471	4560	8640	6840	6848	6879	6931	7003	7095	7205
1280	4222	4257	4305	4364	4435	4515	4604	8704	6854	6862	6893	6945	7017	7109	7219
1344	4268	4302	4349	4408	4478	4558	4647	8768	6868	6875	6906	6958	7031	7123	7233
1408	4312	4345	4391	4450	4520	4600	4689	8832	6881	6889	6920	6972	7045	7137	7247
1472	4355	4388	4433	4491	4561	4641	4730	8896	6895	6903	6934	6986	7059	7151	7261
1536	4398	4429	4474	4532	4601	4681	4770	8960	6908	6916	6946	6999	7072	7164	7274
1600	4439	4470	4514	4571	4640	4720	4809	9024	6922	6930	6960	7012	7086	7178	7288
1664	4480	4509	4553	4610	4679	4758	4848	9088	6935	6943	6973	7026	7099	7192	7302
1728	4519	4548	4591	4648	4716	4796	4885	9152	6949	6956	6987	7039	7112	7205	7315
1792	4558	4586	4629	4686	4753	4833	4922	9216	6962	6969	7000	7052	7126	7219	7329
1856	4595	4623	4666	4721	4790	4869	4959	9280	6975	6983	7013	7065	7139	7232	7343
1920	4633	4660	4702	4757	4825	4905	4995	9344	6988	6996	7026	7079	7152	7245	7356
1984	4669	4696	4737	4792	4860	4940	5030	9408	7001	7009	7039	7092	7165	7259	7370
2048	4707	4731	4772	4827	4894	4974	5064	9472	7015	7023	7053	7106	7179	7273	7384
2112	4740	4765	4806	4860	4928	5008	5098	9536	7028	7035	7065	7118	7191	7285	7396
2176	4774	4799	4839	4894	4961	5041	5131	9600	7040	7048	7078	7130	7204	7298	7410
2240	4808	4832	4872	4926	4994	5074	5164	9664	7053	7060	7091	7143	7217	7311	7423
2304	4841	4865	4904	4958	5026	5106	5197	9728	7066	7073	7103	7156	7230	7324	7436
2368	4873	4896	4936	4989	5057	5137	5228	9792	7079	7086	7116	7169	7243	7337	7449
2432	4906	4929	4968	5021	5089	5169	5260	9856	7092	7098	7129	7181	7256	7350	7462
2496	4937	4960	4998	5052	5119	5199	5291	9920	7104	7111	7141	7194	7268	7363	7475
2560	4968	4991	5029	5082	5149	5230	5321	9984	7117	7123	7154	7207	7281	7375	7488
2624	4999	5021	5059	5112	5179	5259	5351	10048	7129	7136	7166	7219	7294	7388	7501
2688	5029	5050	5088	5141	5208	5288	5381	10112	7142	7148	7178	7231	7306	7400	7513
2752	5059	5080	5117	5170	5237	5318	5410	10176	7154	7161	7191	7244	7319	7413	7526
2816	5088	5109	5146	5199	5266	5346	5439	10240	7166	7173	7203	7256	7331	7426	7539
2880	5117	5137	5174	5227	5294	5375	5467	10304	7179	7185	7215	7268	7343	7438	7551
2944	5145	5165	5202	5255	5322	5402	5495	10368	7191	7197	7227	7281	7356	7451	7564
3008	5173	5193	5230	5283	5350	5430	5523	10432	7203	7210	7240	7294	7369	7464	7577
3072	5201	5220	5257	5309	5376	5457	5550	10496	7215	7222	7252	7306	7381	7476	7589
3136	5228	5247	5284	5336	5403	5484	5577	10560	7227	7234	7264	7317	7392	7487	7601
3200	5255	5274	5310	5362	5429	5510	5604	10624	7239	7246	7276	7329	7404	7500	7614
3264	5282	5300	5336	5388	5455	5537	5630	10688	7251	7258	7288	7341	7416	7512	7626
3328	5309	5326	5362	5414	5481	5563	5656	10752	7263	7270	7300	7353	7428	7524	7638
3392	5334	5352	5388	5440	5507	5588	5682	10816	7275	7281	7312	7365	7440	7536	7651
3456	5360	5377	5413	5465	5532	5613	5708	10880	7287	7293	7323	7377	7452	7548	7663
3520	5385	5403	5439	5490	5557	5638	5733	10944	7299	7305	7335	7389	7464	7560	7675
3584	5410	5427	5462	5514	5581	5662	5757	11008	7311	7317	7347	7401	7476	7572	7687
3648	5435	5452	5487	5538	5605	5686	5781	11072	7322	7328	7358	7412	7487	7583	7698
3712	5459	5476	5511	5562	5630	5712	5807	11136	7334	7340	7370	7424	7499	7595	7711
3776	5483	5500	5535	5586	5654	5736	5831	11200	7346	7352	7382	7436	7511	7607	7723
3840	5507	5524	5559	5610	5677	5759	5854	11264	7357	7363	7393	7447	7522	7619	7735
3904	5531	5547	5582	5633	5700	5782	5877	11328	7369	7375	7405	7459	7534	7631	7747
3968	5554	5571	5605	5656	5724	5806	5902	11392	7380	7386	7416	7470	7545	7642	7758
4032	5578	5594	5628	5679	5747	5829	5925	11456	7392	7397	7427	7481	7557	7654	7770
4096	5601	5616	5650	5702	5769	5852	5948	11520	7403	7409	7439	7493	7569	7666	7782
4160	5623	5639	5673	5724	5792	5875	5971	11584	7414	7420	7450	7504	7580	7677	7793
4224	5646	5661	5695	5746	5814	5897	5994	11648	7425	7431	7461	7515	7591	7688	7804
4288	5668	5683	5717	5768	5836	5919	6016	11712	7437	7443	7473	7527	7603	7700	7817
4352	5690	5705	5739	5790	5858	5941	6038	11776	7448	7454	7484	7538	7614	7712	7828
4416	5712	5727	5760	5811	5879	5963	6060	11840	7459	7465	7495	7549	7625	7723	7840
4480	5734	5748	5782	5833	5901	5984	6081	11904	7471	7476	7506	7560	7637	7734	7851
4544	5755	5770	5803	5854	5922	6006	6103	11968	7482	7487	7517	7571	7648		

## 14 Order Code Chart

HTPA32x32d	R2	<b>L5.0/0.85</b>	F7.7	e	Hi	<b>A</b>	<b>(USB)</b>
HTPA32x32d	R2	<b>L5.0/0.85</b>	F7.7	e	Hi	<b>A</b>	<b>(UDP)</b>
HTPA32x32d	R2	<b>L5.0/0.85</b>	F7.7	e	Hi	<b>M</b>	<b>(UDP)</b>
HTPA32x32d	R2	<b>L5.0/0.85</b>	F7.7	e	Hi	<b>C</b>	
HTPA32x32d	R2	<b>L2.1/0.8</b>	F5.0		Hi	<b>A</b>	<b>(USB)</b>
HTPA32x32d	R2	<b>L2.1/0.8</b>	F5.0		Hi	<b>A</b>	<b>(UDP)</b>
HTPA32x32d	R2	<b>L2.1/0.8</b>	F5.0		Hi	<b>M</b>	<b>(UDP)</b>
HTPA32x32d	R2	<b>L2.1/0.8</b>	F5.0		Hi	<b>C</b>	
HTPA32x32d	R2	<b>L1.6/0.8</b>	F5.0		Hi	<b>A</b>	<b>(USB)</b>
HTPA32x32d	R2	<b>L1.6/0.8</b>	F5.0		Hi	<b>A</b>	<b>(UDP)</b>
HTPA32x32d	R2	<b>L1.6/0.8</b>	F5.0		Hi	<b>M</b>	<b>(UDP)</b>
HTPA32x32d	R2	<b>L1.6/0.8</b>	F5.0		Hi	<b>C</b>	
HTPA32x32d	R2	<b>L2.85/1</b>			Hi	<b>A</b>	<b>(USB)</b>
HTPA32x32d	R2	<b>L2.85/1</b>			Hi	<b>A</b>	<b>(UDP)</b>
HTPA32x32d	R2	<b>L2.85/1</b>			Hi	<b>M</b>	<b>(UDP)</b>
HTPA32x32d	R2	<b>L2.85/1</b>			Hi	<b>C</b>	
HTPA32x32d	R2	<b>L1.9/0.8</b>			Hi	<b>A</b>	<b>(USB)</b>
HTPA32x32d	R2	<b>L1.9/0.8</b>			Hi	<b>A</b>	<b>(UDP)</b>
HTPA32x32d	R2	<b>L1.9/0.8</b>			Hi	<b>M</b>	<b>(UDP)</b>
HTPA32x32d	R2	<b>L1.9/0.8</b>			Hi	<b>C</b>	
HTPA32x32d	R2	<b>L1.8/0.8</b>			Hi	<b>A</b>	<b>(USB)</b>
HTPA32x32d	R2	<b>L1.8/0.8</b>			Hi	<b>A</b>	<b>(UDP)</b>
HTPA32x32d	R2	<b>L1.8/0.8</b>			Hi	<b>M</b>	<b>(UDP)</b>
HTPA32x32d	R2	<b>L1.8/0.8</b>			Hi	<b>C</b>	
HTPA32x32d	R2	<b>L1.7/0.8</b>			Hi	<b>A</b>	<b>(USB)</b>
HTPA32x32d	R2	<b>L1.7/0.8</b>			Hi	<b>A</b>	<b>(UDP)</b>
HTPA32x32d	R2	<b>L1.7/0.8</b>			Hi	<b>M</b>	<b>(UDP)</b>
HTPA32x32d	R2	<b>L1.7/0.8</b>			Hi	<b>C</b>	

**Bold: Selectable options**

Regular: Fixed/Not selectable

# 15 Outer Dimension

